

Architecture overview



EUROPEAN
DATA PORTAL

25–26 November 2015, Berlin



High-level Architecture

Side by side architecture

Harvesting (geo)

Translation

Sync with Virtuoso

Geo search

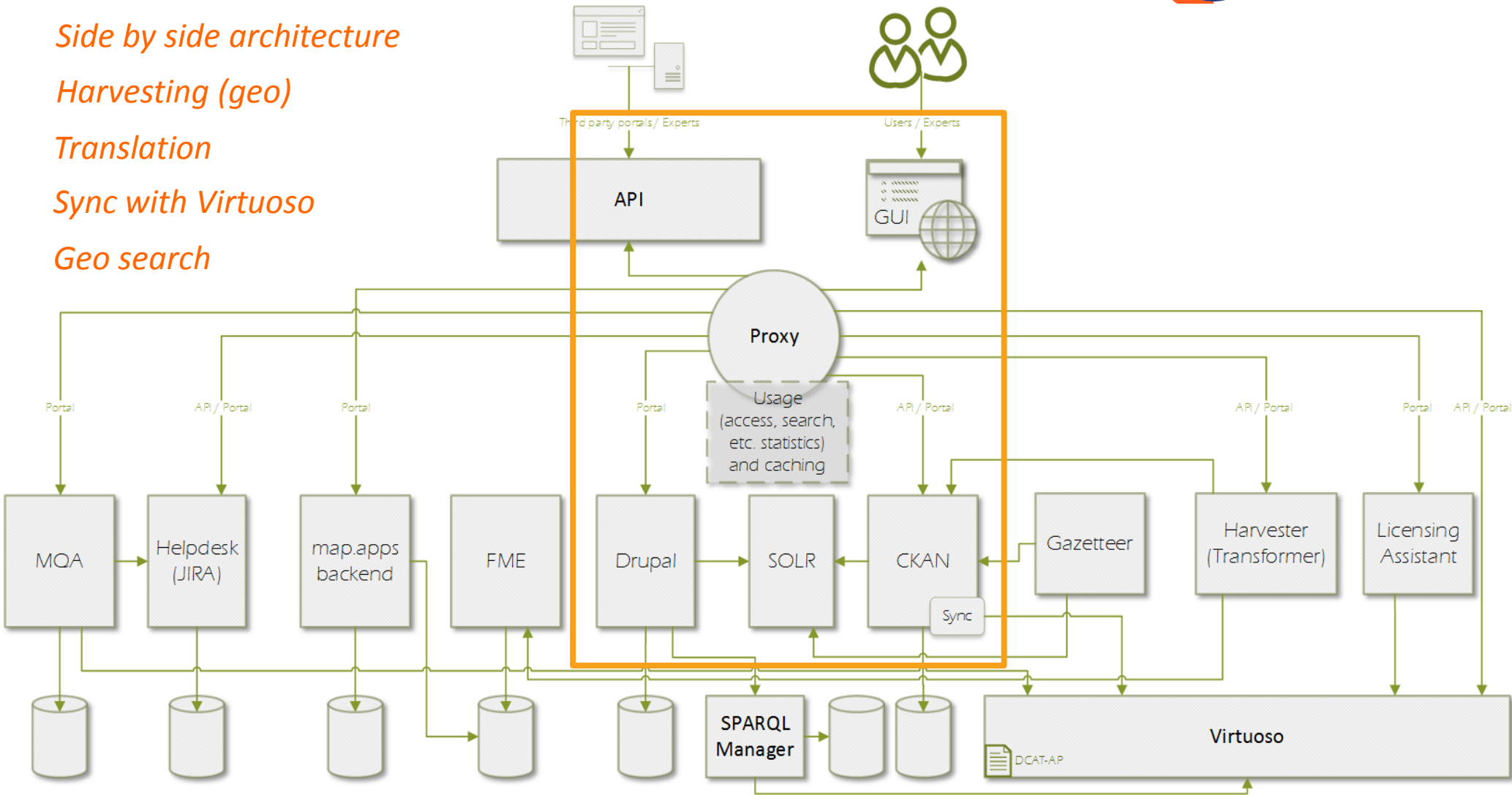

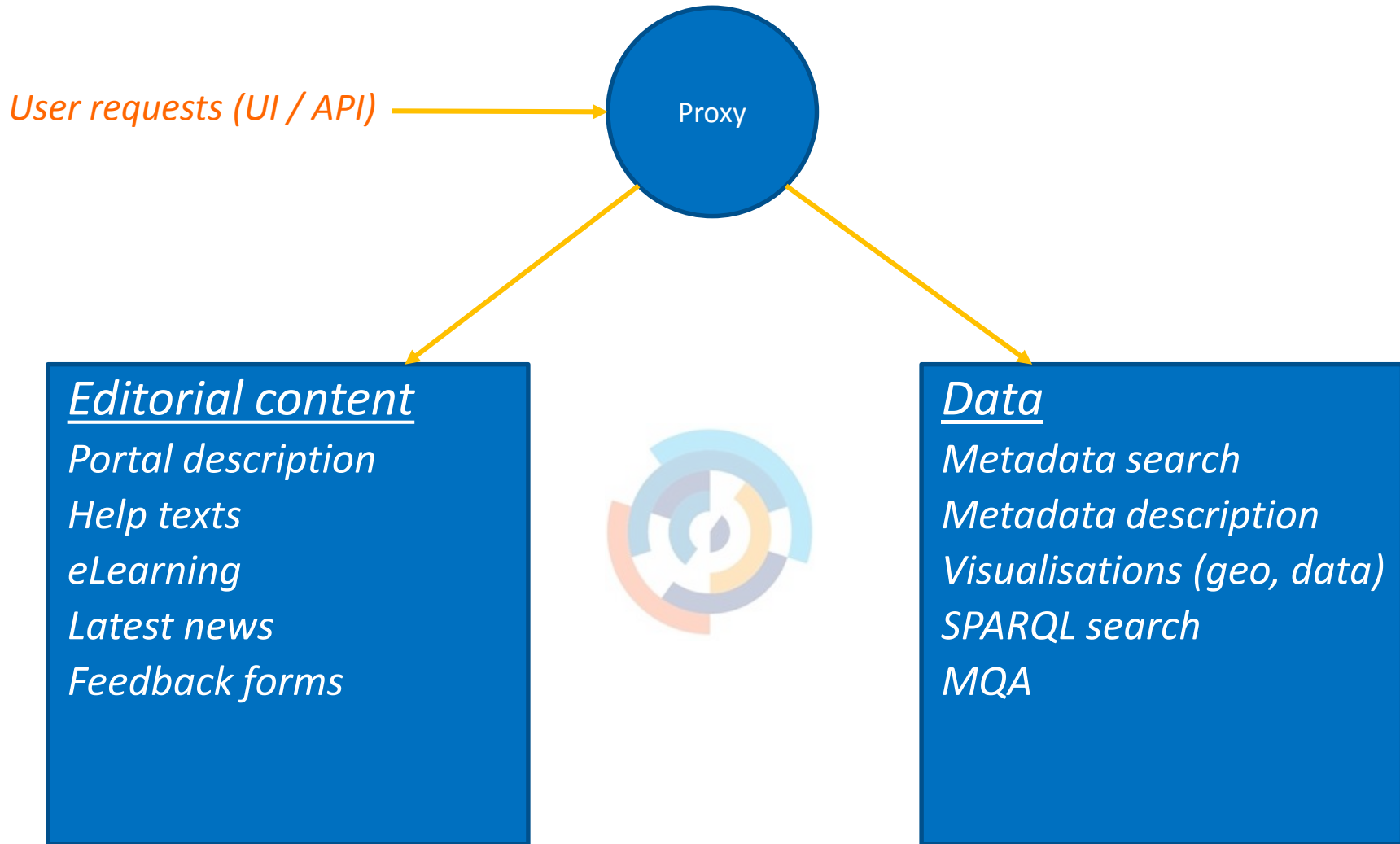

High-level Architecture

Harvesting

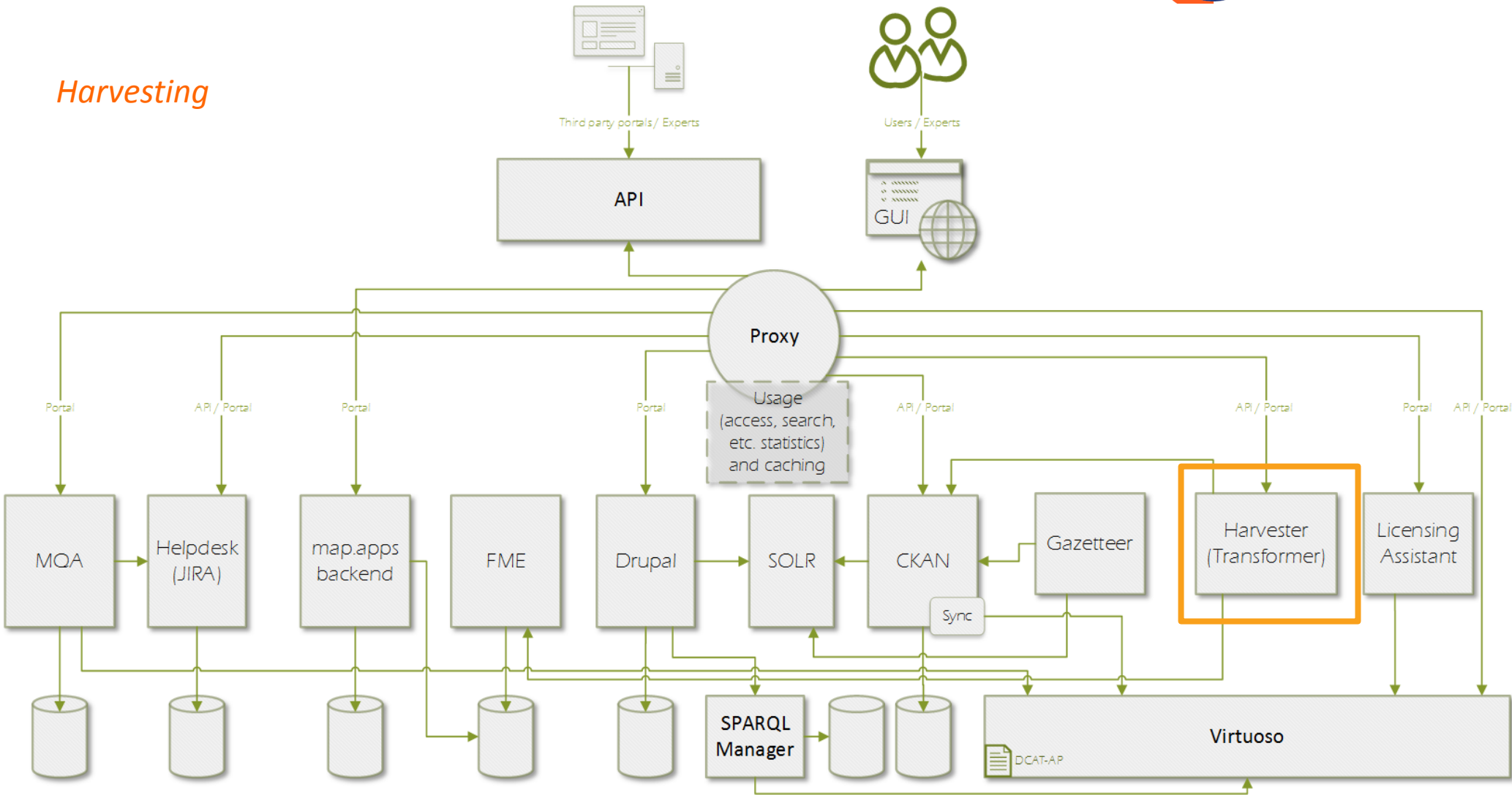

How geo data is harvested

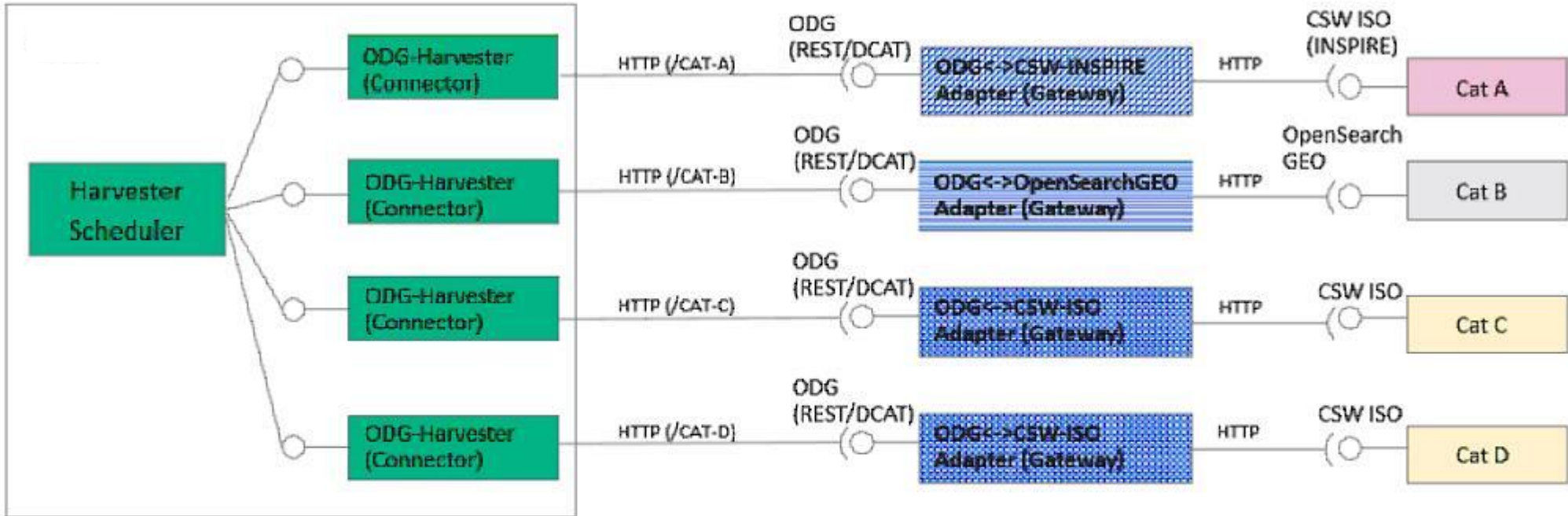

ODG = OpenData GEO

○ — Provided Interface

— () Required Interface

High-level Architecture

Translation

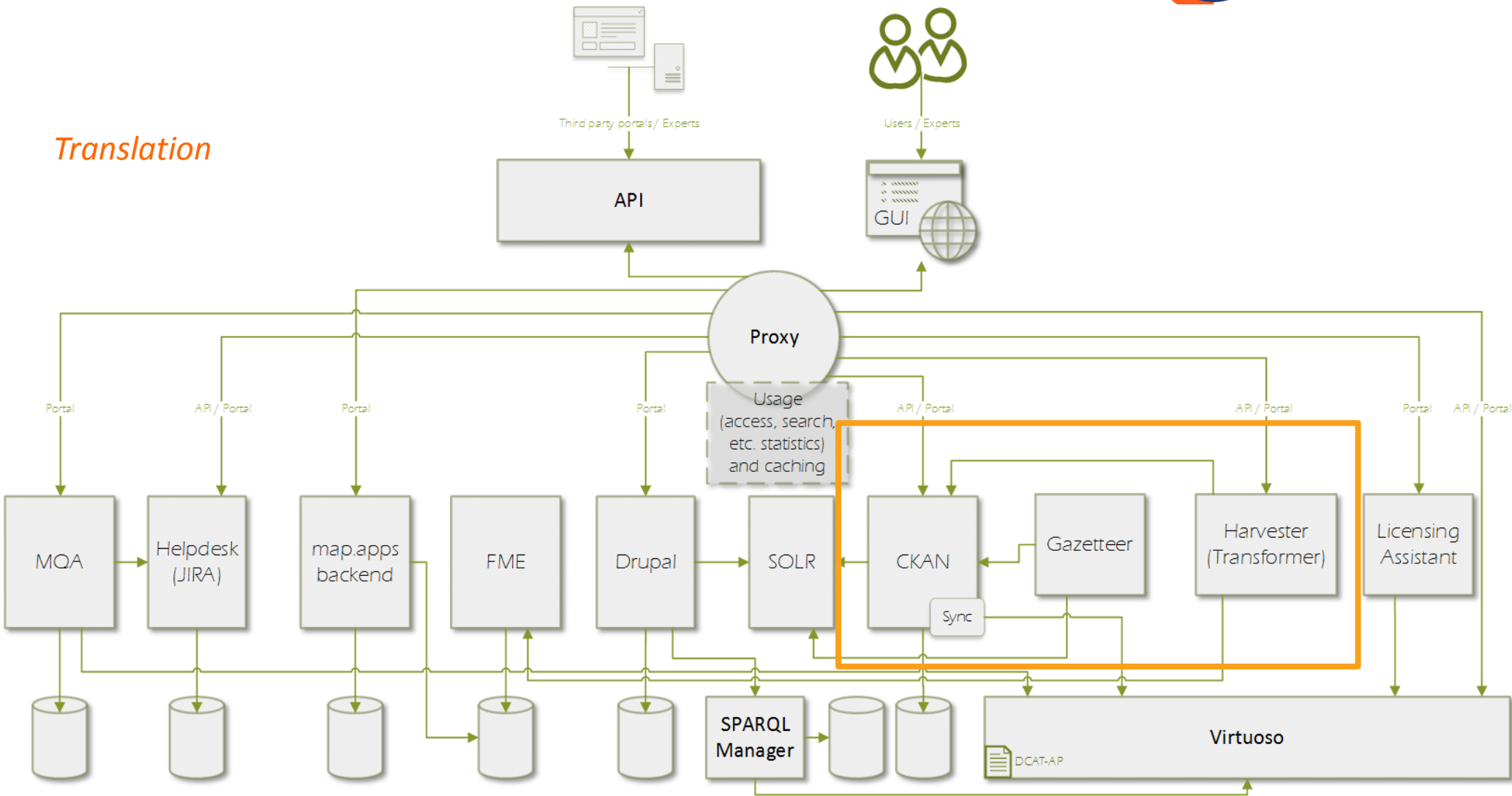

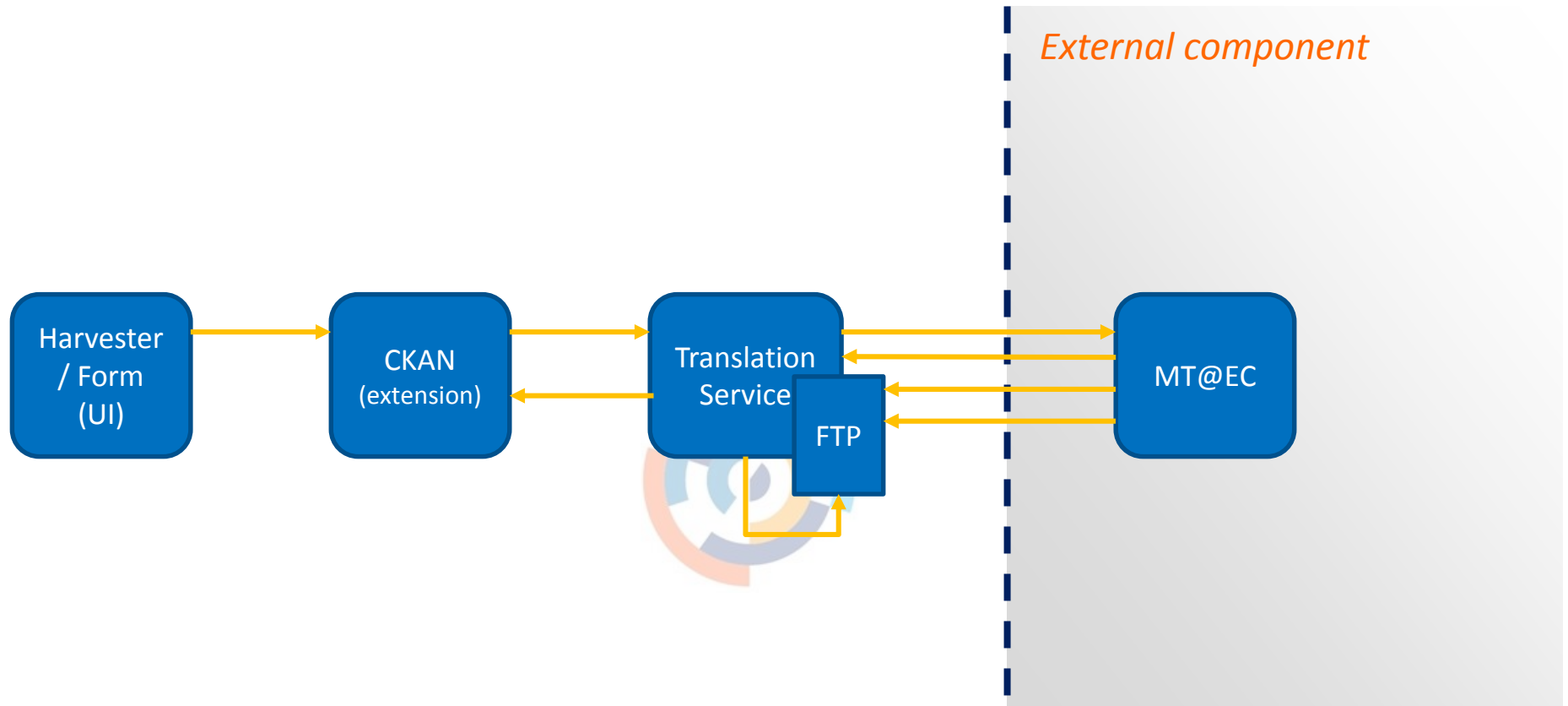

High-level Architecture

Sync with Virtuoso

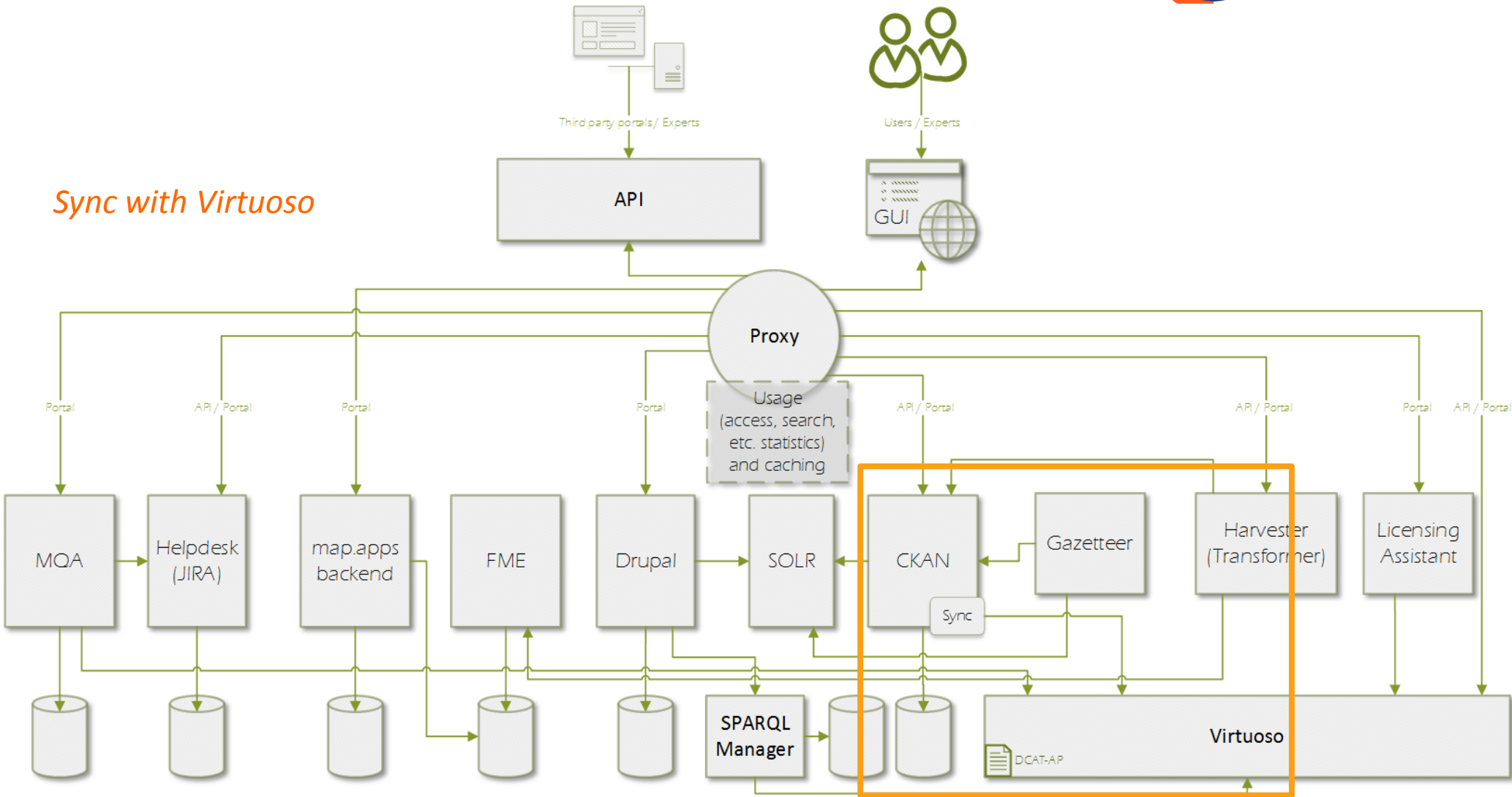

How we sync data to Virtuoso

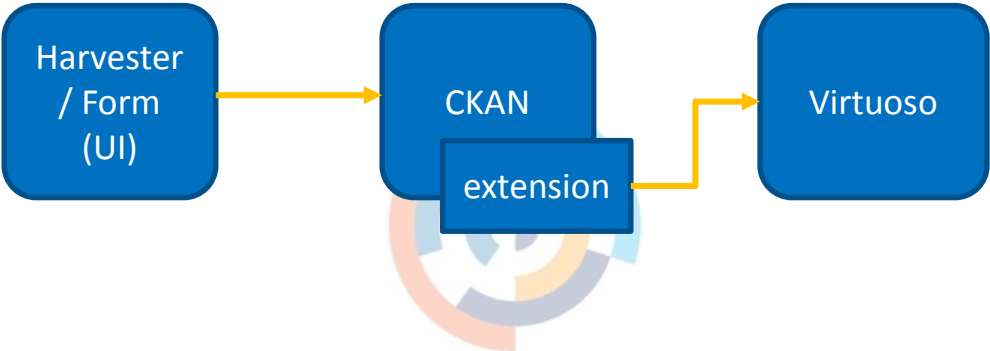

High-level Architecture

Geo search

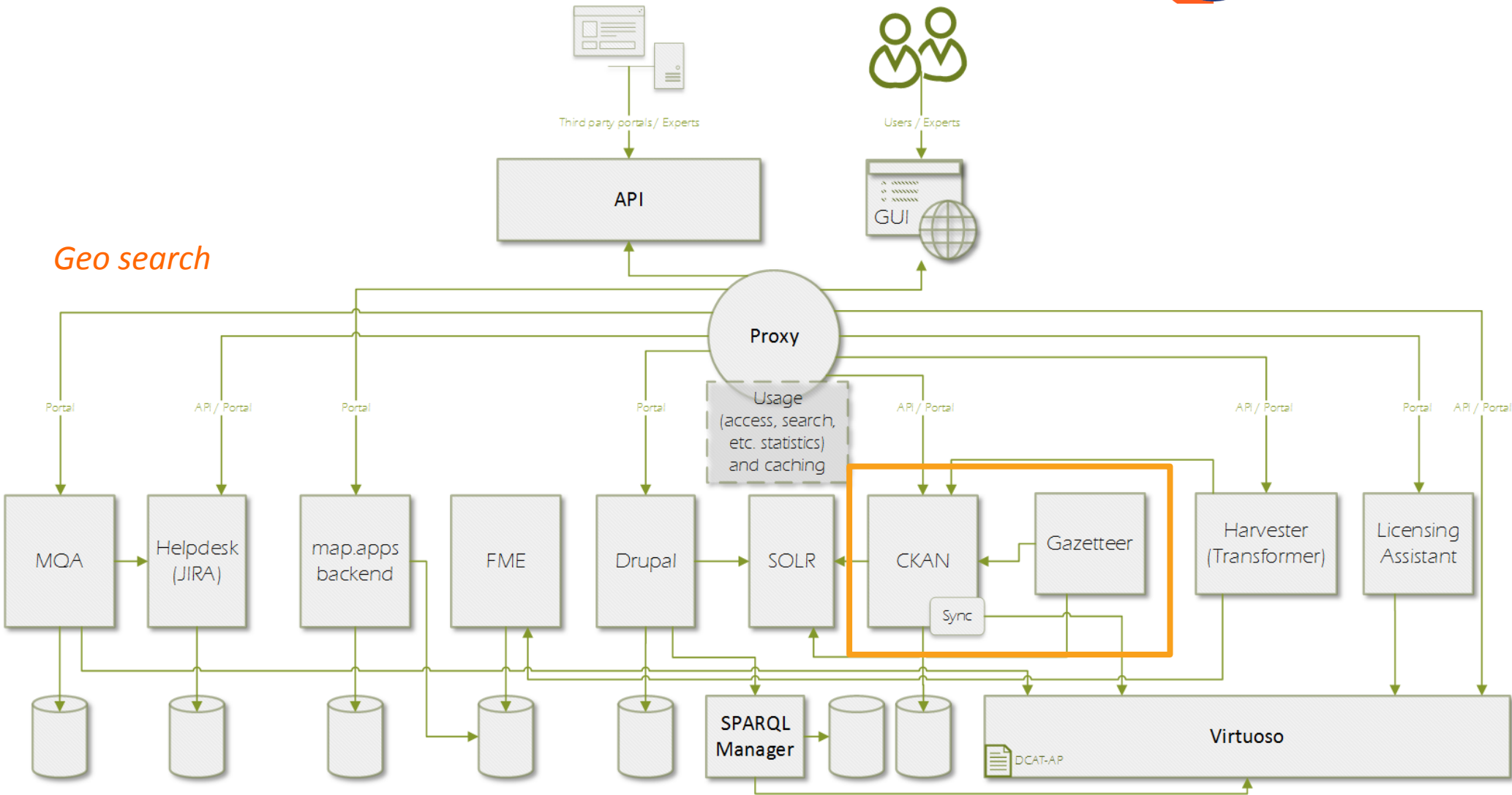

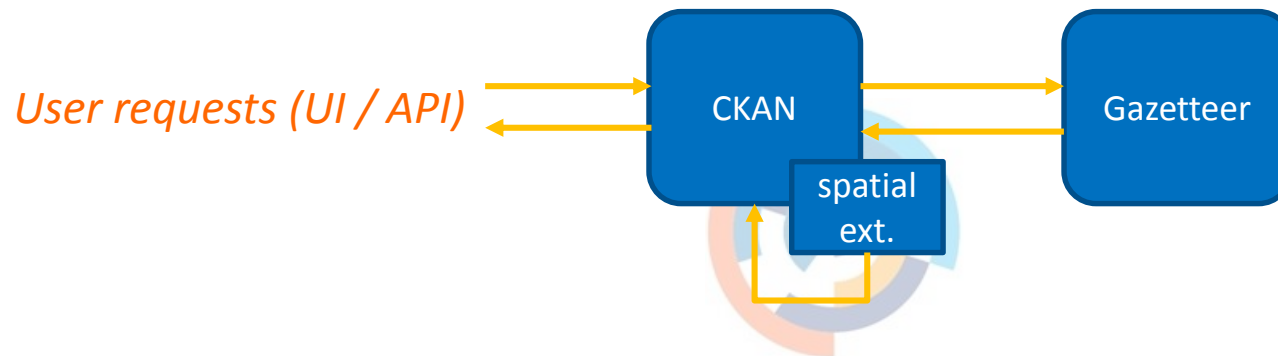

High-level Architecture

